



Antennas for 1100 - 2800 MHz

ORDER NUMBER	TYPE
WS 700 74 17 .	omnidirectional, mast mounting
WS 700 74 1 .	omnidirectional, wall mounting
WS 700 91 4	broadband discone
WS 701 24 19 .	dipole for wall mounting
WS 702 24 18 .	2 element yagi for mast and wall mounting

wipic

OMNIDIRECTIONAL ANTENNA
WS 700 74 17 .
1200 ... 1900 MHz

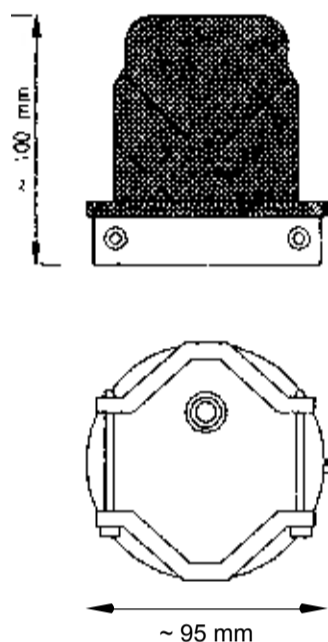

TYPE NO.

WS 700 74 17 8 :	1710 - 1900 MHz
WS 700 74 17 7 :	1550 - 1710 MHz
WS 700 74 17 6 :	1400 - 1550 MHz
WS 700 74 17 5 :	1250 - 1400 MHz

further frequencies on request

DESCRIPTION with white or black radome
 The radome protects the antenna dipole from environmental influences, icing, and increases the lightning protection.

POLARIZATION vertical

IMPEDANCE 50 Ω

GAIN 0 dB (ref. λ/2 dipole)

VSWR < 1.3, at the limits of the band <1.5

POWER max. 100 watts

3 dB BEAMWIDTH horizontal, H plane: 360°
 vertical, E plane: 78°

TERMINATION N or TNC female
 other termination on request

GROUNDING all metal parts are DC grounded

MOUNTING to 45 - 60 mm ø mast
 cable runes inside or outside the mast

MATERIAL aluminium, bolts of stainless steel, weather-resistant plastics, radome of UV-stabilized polyethylene

WEIGHT 0.43 kg
WIND AREA 0.01 m²
WIND LOAD 12 N (150 km/h)
 9 N (130 km/h)

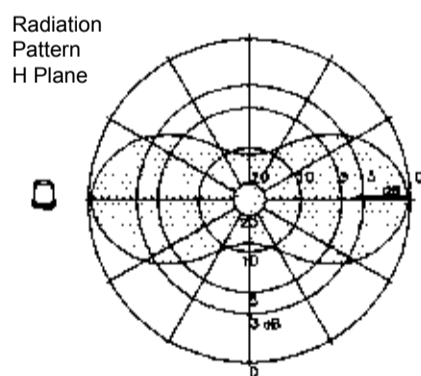

KW 1-08

WIPIC reserves the right to amend specifications in the light of continuing development.

wipic

ANTENNA FOR MOUNTING ON WALLS
WS 700 74 1.
1250 - 1400 MHz

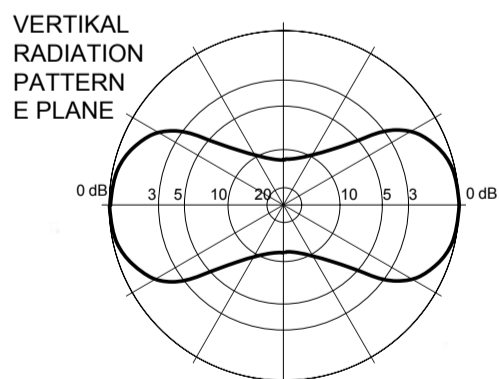
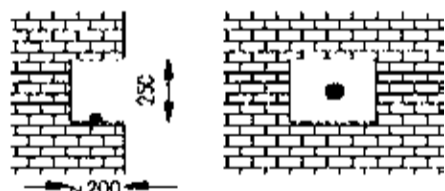
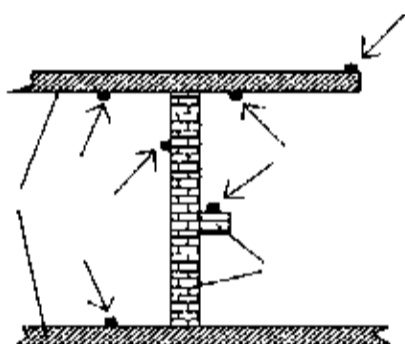
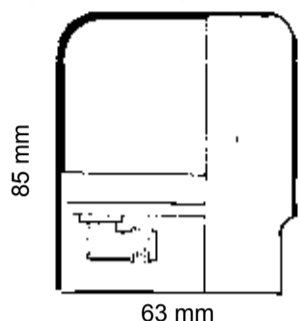

TYPE NO.	WS 700 74 18 : 1710 - 1900 MHz WS 700 74 17 : 1550 - 1710 MHz WS 700 74 16 : 1400 - 1550 MHz WS 700 74 15 : 1250 - 1400 MHz further frequencies on request
DESCRIPTION	antenna with whitero black radome. The antenna needs no counterpoise and works on walls of brick or concrete.
POLARIZATION	vertical or horizontal (depends on mounting)
IMPEDANCE	50 Ω
GAIN	0 dB (ref. λ/2 dipole)
VSWR	< 1.3, at the limits of the band <1.4
POWER	max. 100 watts
3 dB BEAMWIDTH	horizontal, H plane: 360° vertical, E plane: 78°
TERMINATION	N or TNC female
GROUNDING	all metal parts are DC grounded
MOUNTING	with 3 bolts and 3 dowels (included)
MATERIAL	aluminium, bolts of stainless steel, weather-resistant plastics, radome of UV-stablized polyethylene
WEIGHT	0.2 kg
WIND AREA	0.01 m ²
WIND LOAD	13 N (150 km/h) 10 N (130 km/h)

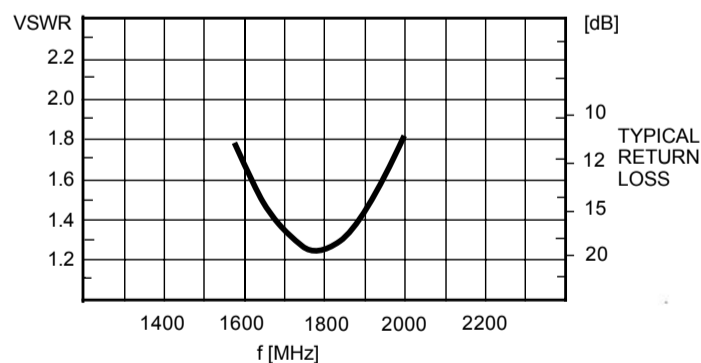

KW 1-08

WIPIIC reserves the right to amend specifications in the light of continuing development.



DISCONE ANTENNA
WS 700 91 4
800 - 2800 MHz

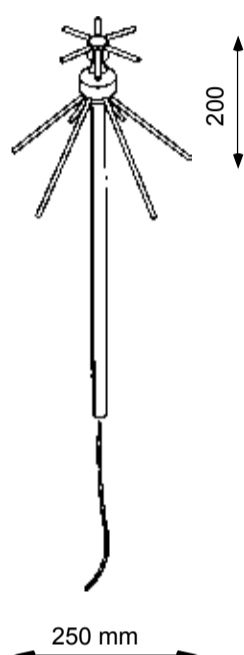

TYPE NO.	WS 700 91 4: 800 - 2800 MHz further frequencies on request
DESCRIPTION	light broadband omnidirectional antenna
POLARIZATION	vertical
IMPEDANCE	50 Ω
GAIN	0 dB (ref. λ/2 dipole)
VSWR	< 3 from 800 - 2400 MHz < 5 from 800 - 2800 MHz
POWER	max. 150 watts
3 dB BEAMWIDTH	horizontal, H plane: 360° vertical, E plane: 78°
TERMINATION	1 m cable RG 213/U ending with N male other termination on request
GROUNDING	radiator not grounded
MOUNTING	to 30 - 80 mm ø mast with WG 21 cable runs outside the mast
MATERIAL	aluminium, bolts of stainless steel, weather-resistant plastics, UV-stabilized plastics
WEIGHT	0.9 kg
WIND AREA	0.04 m ²
WIND LOAD	51 N (150 km/h) 38 N (130 km/h)

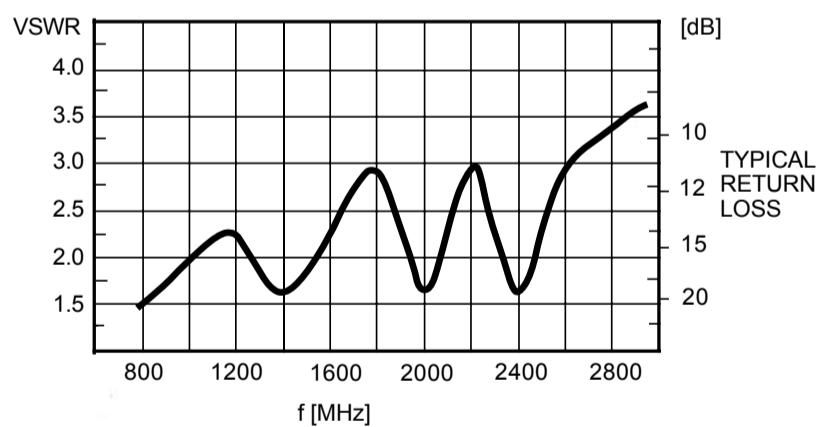

KW 1-08

WIPIC reserves the right to amend specifications in the light of continuing development.

Section 7. 4/6

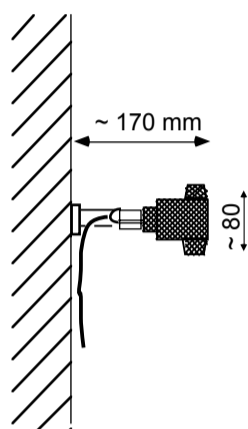
wipic
DIPOLE FOR WALL MOUNTING
WS 701 24 19 .
1400 ... 1900 MHz

TYPE NO.	WS 701 24 19 5: 1400 - 1600 MHz WS 701 24 19 6: 1600 - 1900 MHz further frequencies on request
DESCRIPTION	dipole with radome The radome protects the antenna dipole from environmental influences, icing, and increases the lightning protection.
POLARIZATION	vertical (horizontal on request)
IMPEDANCE	50 Ω
GAIN	0 - 6 dB (ref. $\lambda/2$ dipole), depends on wall construction
VSWR	< 1.3, at the limits of the band <1.5
POWER	max. 100 watts
3 dB BEAMWIDTH	horizontal, H plane: 360° vertical, E plane: 78° (depends on wall construction)
TERMINATION	~ 0.5 m cable RG 303/U ending with N male other termination on request
GROUNDING	all metal parts are DC grounded
MOUNTING	on walls with flange no. 22 (see chapter 10)
MATERIAL	aluminium, bolts of stainless steel, weather-resistant plastics, radome of UV-stabilized polyethylene
WEIGHT	0.5 kg
WIND AREA	0.01 m ²
WIND LOAD	12 N (150 km/h) 9 N (130 km/h)

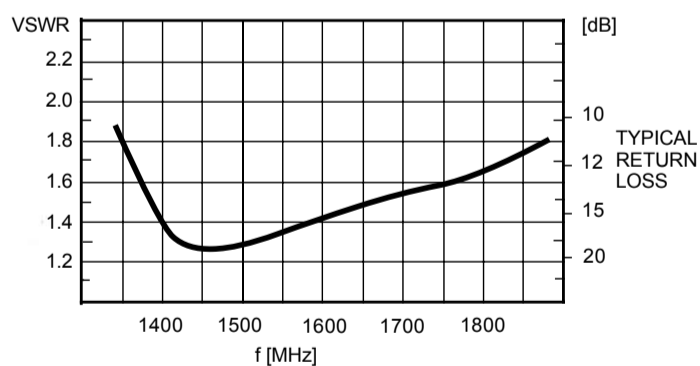

KW 1-08

WIPIC reserves the right to amend specifications in the light of continuing development.



DIRECTIONAL ANTENNA FOR MAST AND WALL MOUNTING
WS 702 24 18
1350 ... 1900 MHz

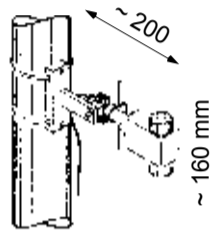

TYPE NO.	WS 702 24 18 5 : 1350 - 1650 MHz WS 702 24 18 6 : 1600 - 1900 MHz further frequencies on request
DESCRIPTION	dipole with radome The radome protects the antenna dipole from environmental influences, icing, and increases the lightning protection.
POLARISATION	vertical (horizontal on request)
IMPEDANCE	50 Ω
GAIN	3 dB (ref. λ/2 dipole)
VSWR	< 1.3, at the limits of the band <1.4
POWER	max. 100 watts
3 dB BEAMWIDTH	horizontal, H plane: 175° vertikal, E plane: 76°
TERMINATION	~ 0.5 m cable RG 303/U ending with N male other termination on request
GROUNDING	all metal parts are DC grounded
MOUNTING	with steel-band to mast with two bolts or dowels
MATERIAL	aluminium, bolts of stainless steel, weather-resistant plastics, radome of UV-stabilized polyethylene
WEIGHT	0.6 kg
WIND AREA	0.01 m ²
WIND LOAD	12 N (150 km/h) 9 N (130 km/h)

Horizontal
Radiation
Pattern
H Plane

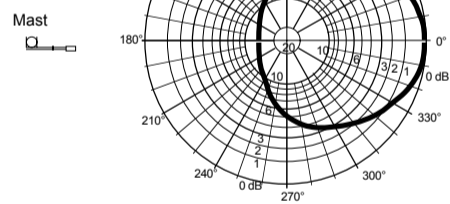

Vertical
Radiation
Pattern
E Plane

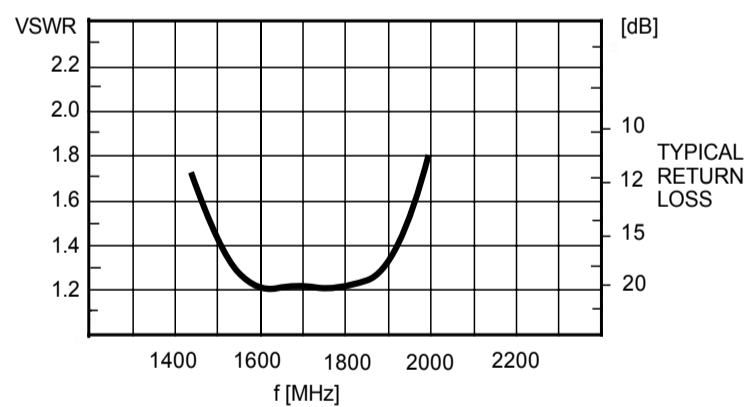
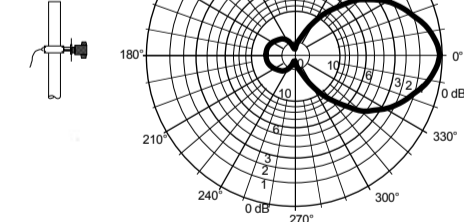

KW 1-08

WIPIC reserves the right to amend specifications in the light of continuing development.